



Les enseignes de la gamme Formulate sont idéales pour être vu de loin. Cette solution légère, rapide à installer, vous procure un moyen de communication original et optimal.

Caractéristiques

- Structure tubulaire manchonnable en aluminium anodisé (Ø 30 mm)
- Système d'élingage inclus (câblages, pitons et mousquetons)
- Sac de transport inclus (1 à 3 sacs selon le format)
- Production à la commande

Les + produit

- Facilité de montage (repérage des sections par numérotation)
- Rapidité d'assemblage avec le bouton poussoir
- Communication recto-verso
- Toolkit inclus (paire de gants et clés allen)
- Disponible en format sur-mesure
- Fabrication Française

Média recommandé

- Textile légèrement extensible
- Nous recommandons une finition housse avec fermeture Éclair
- Dimensions visibles : FMH-RNG-S75 : 750 (h) x Ø1500 mm
FMH-RNG-M100 : 1000 (h) x Ø2500 mm
FMH-RNG-L100 : 1000 (h) x Ø3500 mm
FMH-RNG-XL120 : 1200 (h) x Ø5000 mm

Les gabarits d'impression mis à disposition sont fournis à titre indicatif. Ils tiennent compte de procédés internes qui peuvent varier selon vos équipements, matières & finitions. En cas d'impression par vos soins, il vous appartient de tester au préalable la compatibilité de votre media avec le produit avant utilisation.



Points d'accroche en
métal

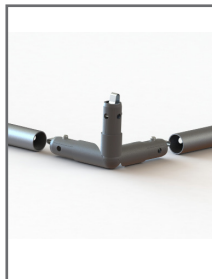

Bouton poussoir



Sac de transport matelassé inclus :



Référence structure	Référence sac	Nombre de sac par format	Dimensions d'un sac (mm) h x l x p
FMH-RNG-S75	ABVSS-03	1	50 x 1250 x 260
FMH-RNG-M100	ABVSS-03	2	50 x 1250 x 260
FMH-RNG-L100	ABVSS-04	2	50 x 1560 x 260
FMH-RNG-XL120	ABVSS-04	3	50 x 1560 x 260

Informations structure

Référence	Désignation	Dimensions structure assemblée (mm) h x Ø	Poids structure assemblée	Dimensions colis (mm) h x l x p	Poids colis
FMH-RNG-S75	MS Ring 1500	750 x 1500	5 kg	100 x 1550 x 300	6 kg
FMH-RNG-M100	MS Ring 2500	1000 x 2500	9 kg	2 colis : 100 x 1550 x 300 (unité)	10 kg
FMH-RNG-L100	MS Ring 3500	1000 x 3500	12 kg	2 colis : 100 x 1860 x 300 (unité)	13 kg
FMH-RNG-XL120	MS Ring 5000	1200 x 5000	17 kg	3 colis : 100 x 1860 x 300 (unité)	18 kg

Composition de la structure et plan de montage FMH-RNG-S75

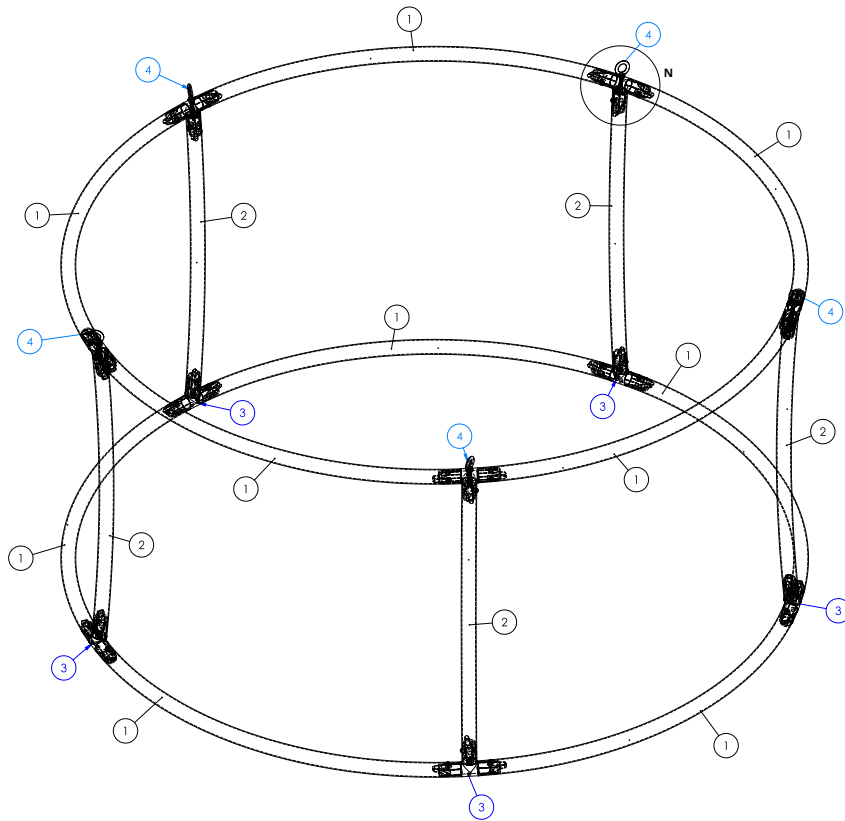

1

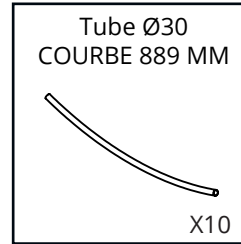

2

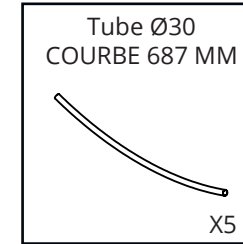

3

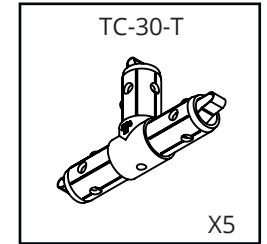

4

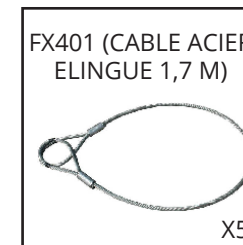
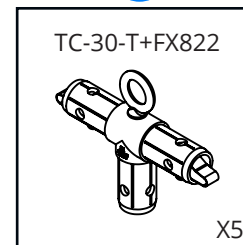

Composition de la structure et plan de montage FMH-RNG-M100

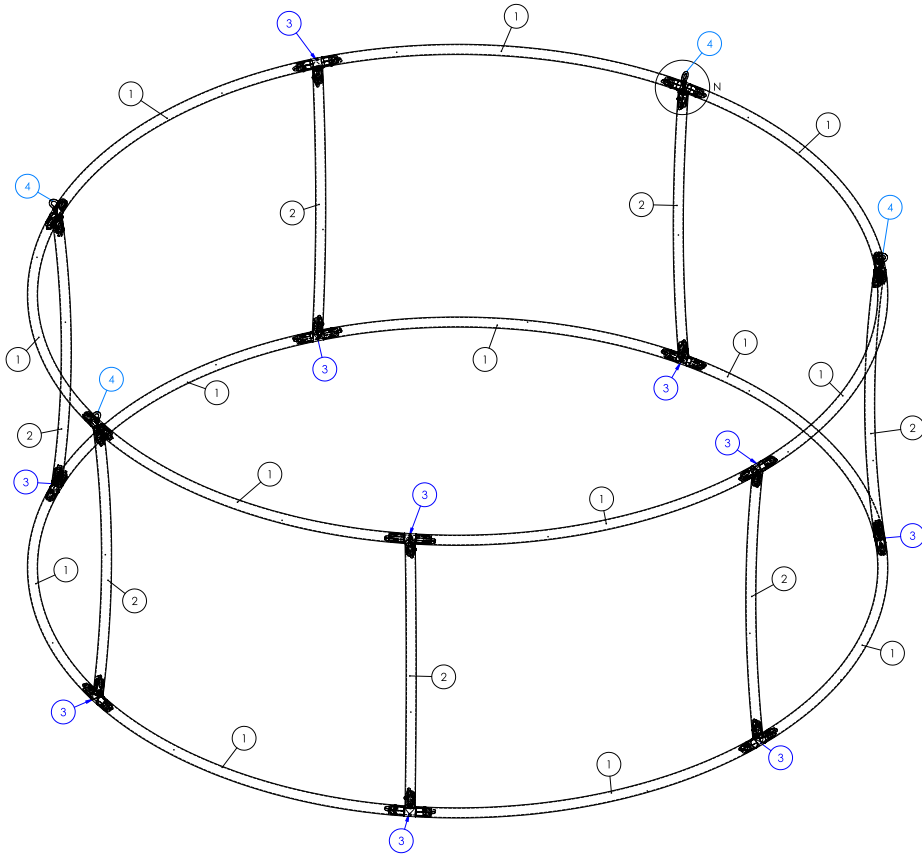

1

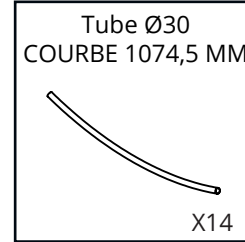

2

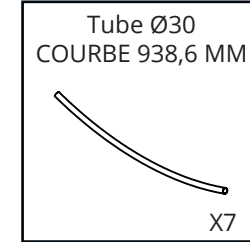

3

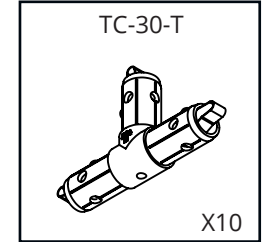

4

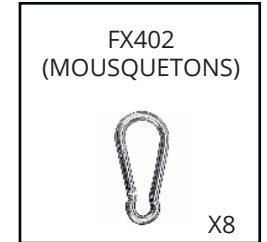
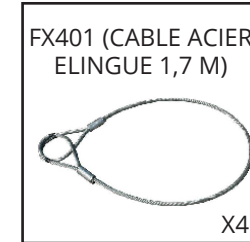
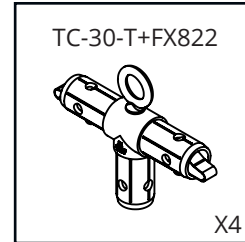

Composition de la structure et plan de montage FMH-RNG-L100

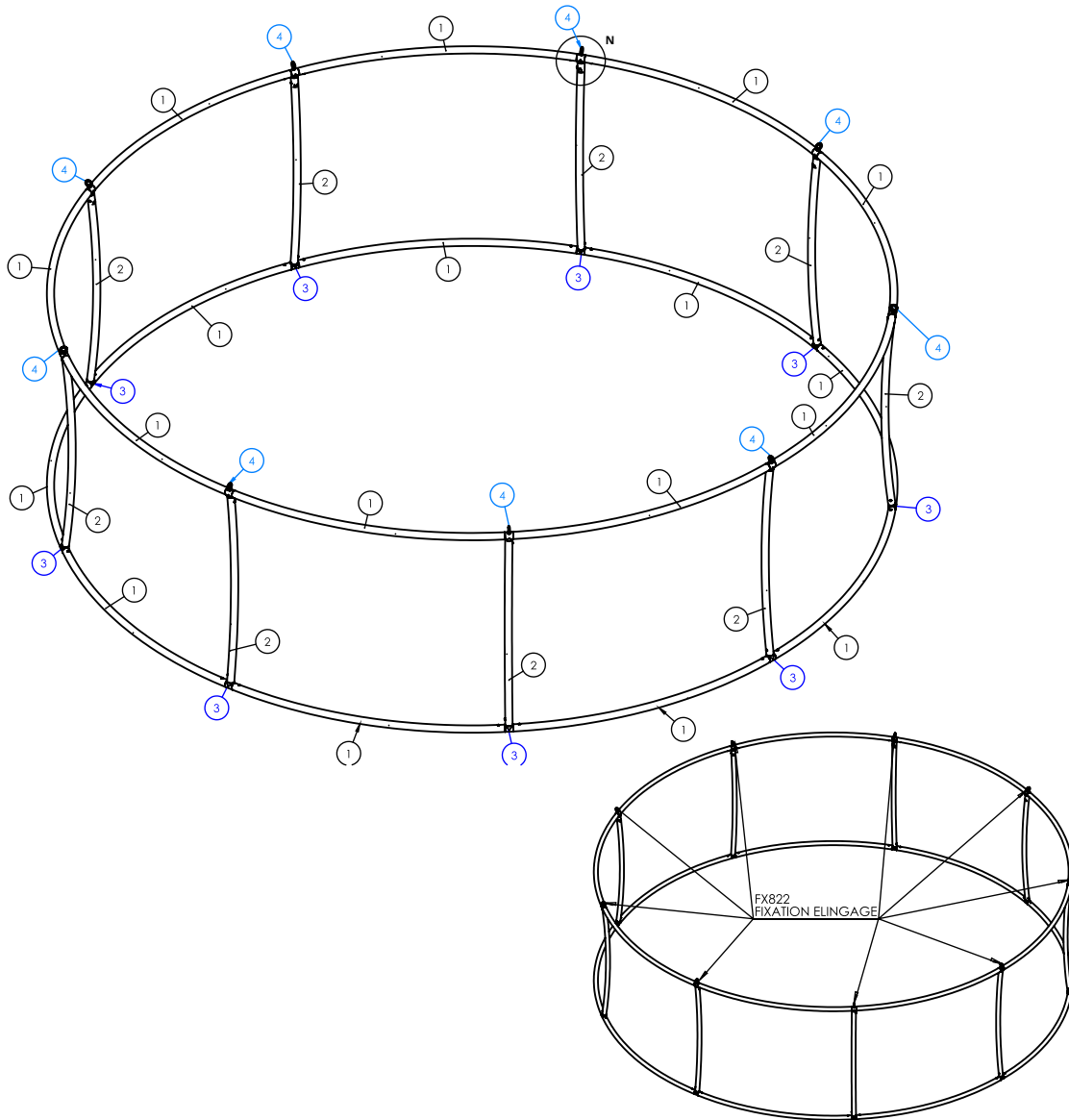

1

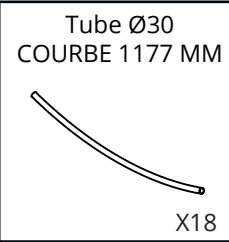

2

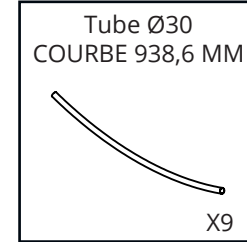

3

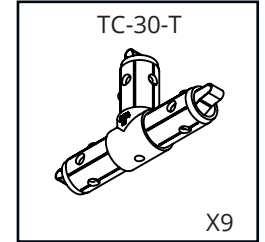

4

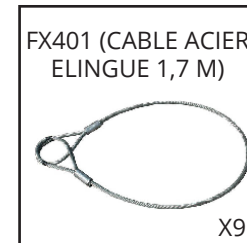
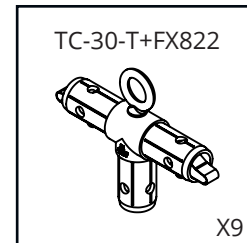

Composition de la structure et plan de montage FMH-RNG-XL120

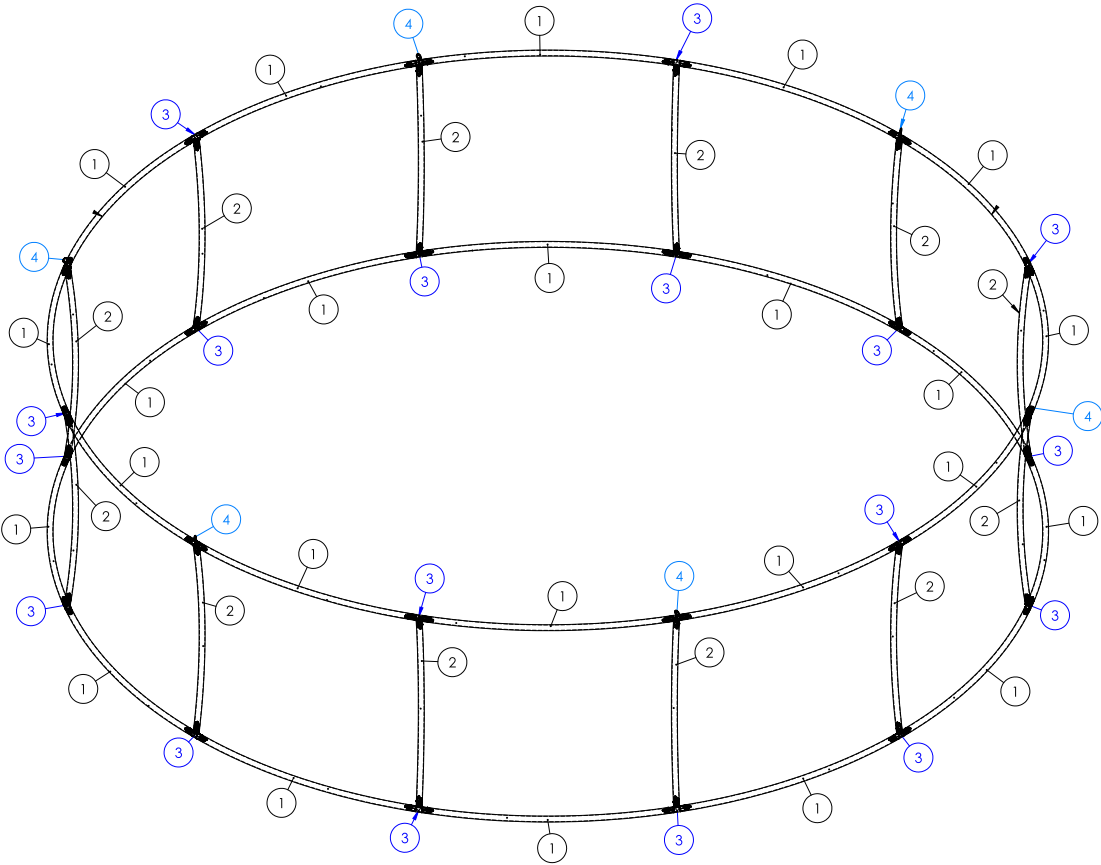

1

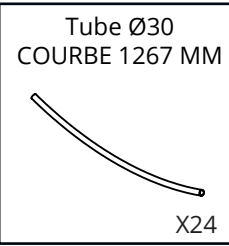

2

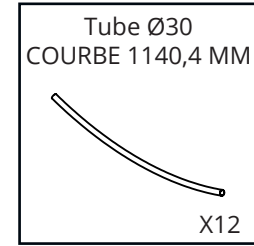

3

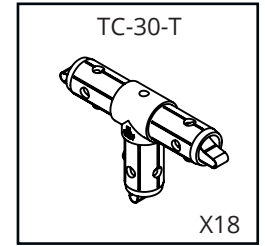

4

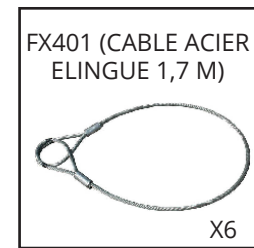
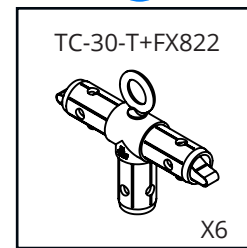

Assemblage des sections de la structure

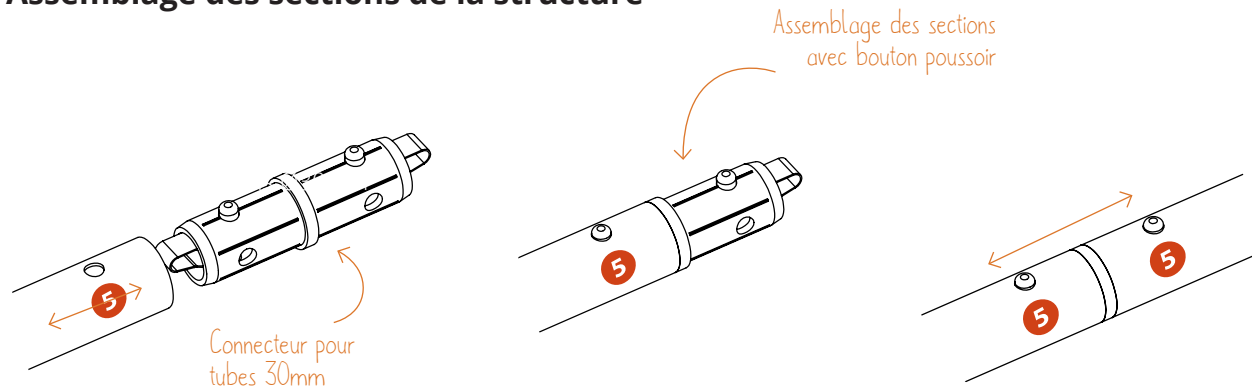

Assemblage du textile

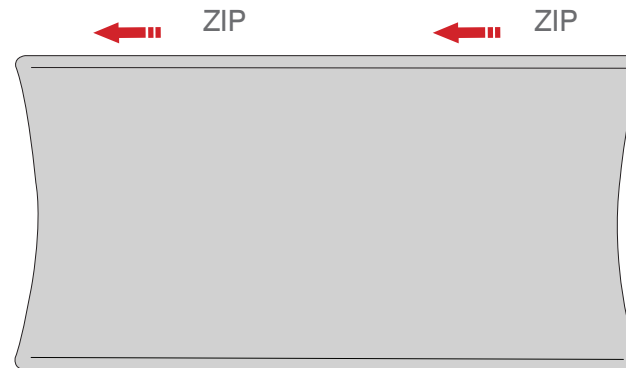

Le visuel est à enfiler par le bas.